

OWNER'S MANUAL

P/N E055-71520302  
P/N E055-71520305

**FAN COIL  
PROGRAMMABLE  
DIGITAL THERMOSTAT**

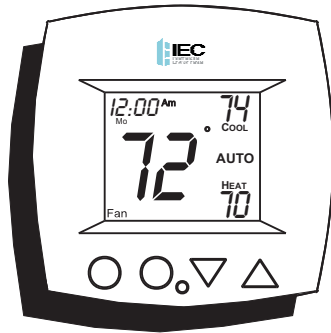

- 2- or 4-pipe configurable
- Dual or Single Setpoint
- 7 Day Programmable
- 3 Occupied, 1 Unoccupied
- Very easy to program
- Large, easy to read display
- Thermoglow™ Backlight
- Auto-Changeover
- Locking Keypad
- Override capable

Meets California Title 24

- *Auto-Changeover is available in 4-pipe systems, in 2-pipe systems with Electric Heat, or when used with G100-71520306 accessory, auto-changeover sensor.*



© Copyright 2007, International Environmental Corp. All Rights Reserved

## Table Of Contents

FRONT PANEL	2
DISPLAY	3
QUICK START <i>Set the clock and go</i>	6
SELECTING THE HEAT OR COOL MODE	7
BASIC OPERATION	11
OVERRIDING THE DAILY SCHEDULE	12
PROGRAMMING <i>Occupied / Unoccupied</i>	13
ADVANCED SETUP	18
ABOUT ADVANCED FEATURES & OPERATION	24
WARRANTY	33

---

**CAUTION** Follow Installation Instructions carefully. Disconnect Power to the Heater/Air Conditioner before removing the old thermostat and installing the new thermostat.



**WARNING**

---

P/N E055-71520302 and P/N E055-71520305

© Copyright 2007, International  
Environmental Corp. All Rights Reserved

## Front Panel

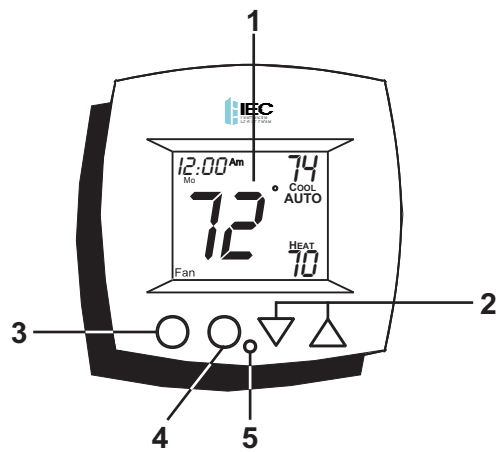

- 1 Liquid Crystal Display  
*with Thermoglow*
- 2 Up/Down Buttons
- 3 Mode Button
- 4 Fan/Override Button
- 5 Heat or Cool Indicator  
*Heat = Red, Cool = Green*

## Display

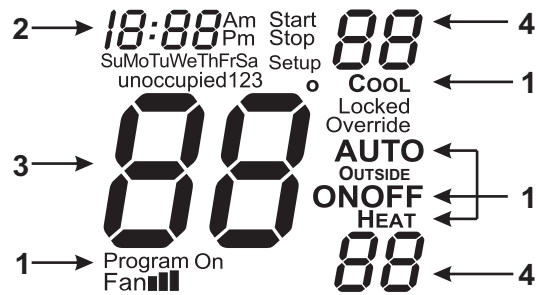

- 1 Mode Indicators - *Page 7-10*  
Selects the operational mode of the equipment.  
**HEAT** - Indicates the heating mode.  
**COOL** - Indicates the cooling mode.  
**AUTO** - Indicates the system will automatically changeover between heat and cool modes as the temperature varies.  
**PROGRAM ON** - Indicates the time period program is enabled to run.  
**OFF** - Indicates heating and cooling are turned off.
- 2 Clock with Day of the Week - *Page 6*  
Indicates the current time and day. This clock is also used to program the time period schedules.
- 3 Room Temperature Display  
Indicates current room temperature.
- 4 Desired Set Temperature - *Page 11*  
Indicates desired room temperature(s).

## Display

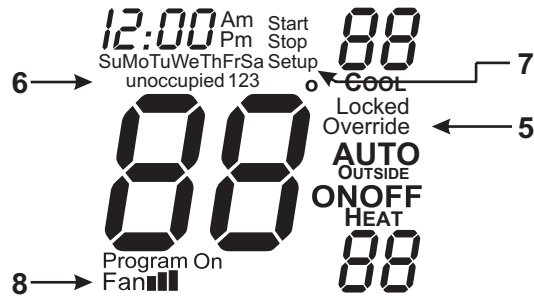

- 5 Override icon - Pages 12 & 21**  
Indicates the program is currently being overridden for up to six hours.
- 6 Occupied & Unoccupied icons - Pages 13-16**  
Indicates the program number: Occupied 1,2,3 or Unoccupied.
- 7 Setup icon - Pages 18-22**  
Indicates the thermostat is in the advanced setup mode.
- 8 Fan ■■■ icon - Page 11**  
Indicates fan operation.  
**Fan ■** = low speed  
**Fan ■■** = medium speed  
**Fan ■■■** = high speed  
 When only the **Fan** icon is displayed, the fan is in the Auto mode and will run only when necessary to heat or cool.

## Display

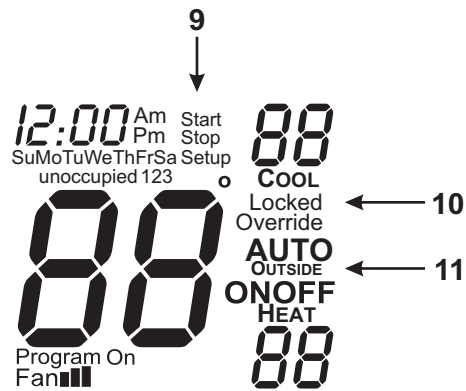

- 9 Start & Stop icons - Pages 14-16**  
Appear when programming occupied time periods.
- 10 Locked icon - Page 30**  
Indicates keypad has been locked.
- 11 Outside icon - Pages 21 & 31**  
Indicates the temperature displayed is from the optional outside sensor.

## Quick Start *Set the Clock and Go*

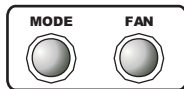

Press the MODE and FAN buttons at the same time for two seconds to enter Setup screens.

### Setting the Clock

**Tip:** To change hours quickly, press and hold the FAN button and press the UP or DOWN button.

12:00<sup>Am</sup> Setup 1

During Setup and Programming:  
Pressing the UP or DOWN button will modify the flashing selection.

To adjust the Clock or Day use



buttons.

### Setting the Day

Mo Setup 2

Press  
MODE

Press the MODE and FAN buttons at the same time to return to normal operation.

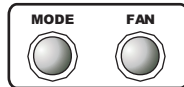

The thermostat is preprogrammed from the factory to operate a 4 pipe system without the need for further programming. To optimize the installation of this thermostat for a 2 pipe system, follow the instructions in the Advanced Setup section. *Page 19*

## Selecting the Heat or Cool Mode 4-Pipe Operation

### Select Mode by Pressing the MODE Button

#### Heating Only

The **HEAT** setting indicates the temperature the room has to reach before the heating source will turn on to heat the room.

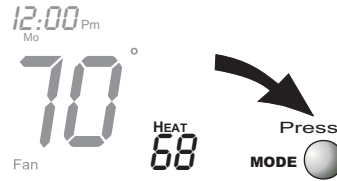

#### Cooling Only

The **COOL** setting indicates the temperature the room has to reach before the cooling source will turn on to cool the room.

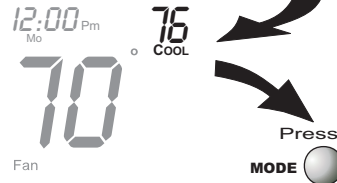

#### Heating or Cooling

**AUTO** will automatically select heat or cool based on room temperature demand.

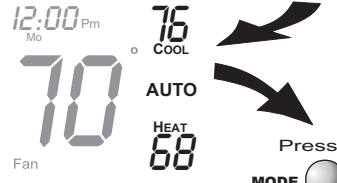

#### Time Schedule for Heating or Cooling

**Program On** will activate the stored timer operation for the heating and cooling setpoints (occupied or unoccupied periods).

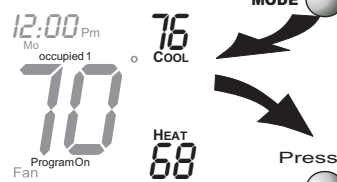

#### Off

**OFF** indicates both heating and cooling are turned off.

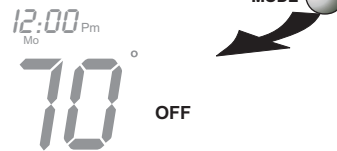

## Selecting the Heat or Cool Mode 2-Pipe Operation

### Heat Only

Step #6 = 1 in the Advanced Setup section, page 19.

#### Heating Only

The **HEAT** setting indicates the temperature the room has to reach before the heating source will turn on to heat the room.

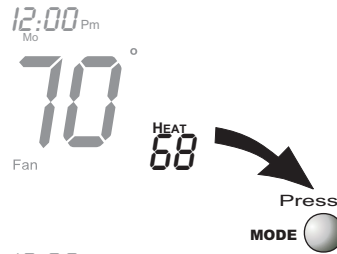

#### Time Schedule for Heating or Cooling

**Program On** will activate the stored timer operation for the heating and cooling setpoints (occupied or unoccupied periods).

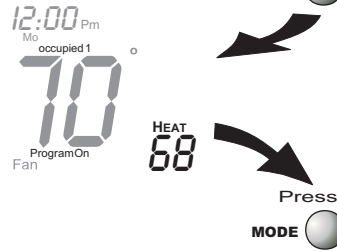

#### Off

**OFF** indicates both heating and cooling are turned off.



**Selecting the Heat or Cool Mode 2-Pipe Operation**

**Cool Only**

*Step #6 = 2 in the Advanced Setup section, page 19.*

**Cooling Only**

The **COOL** setting indicates the temperature the room has to reach before the cooling source will turn on to cool the room.

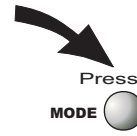

**Time Schedule for Heating or Cooling**

**Program On** will activate the stored timer operation for the heating and cooling setpoints (occupied or unoccupied periods).



**Off**

**OFF** indicates both heating and cooling are turned off.

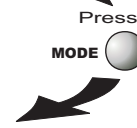

## Selecting the Heat or Cool Mode 2-Pipe Operation

### Heating and/or Cooling

Step #6 = 3 in Advanced Setup (page 19), and the accessory changeover sensor (G100-71520306) is used.  
Step #6 = 4 or 5 in Advanced Setup (page 19).  
Operation is the same as a 4-pipe system (page 7).

**HEAT** indicates the temperature the room has to reach before the heating source energizes. If the water supply is cold, this screen and heating would be locked out.

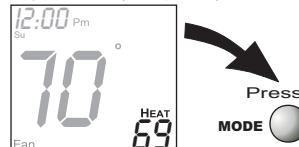

**COOL** indicates the temperature the room has to reach before the cooling source energizes. If the water supply is hot, this screen and cooling would be locked out.

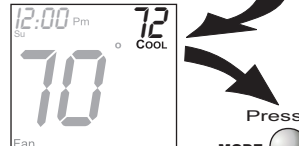

*If step #6 = 3, this screen will not appear.*

**AUTO** will automatically select heat or cool based on the room temperature demand.

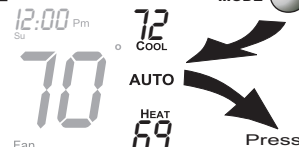

*If step #6 = 3, only heat or cool will appear.*

**Program On** will activate the stored timer operation for the heating and cooling setpoints.

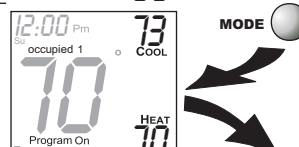

**OFF** indicates both heating and cooling are turned off.

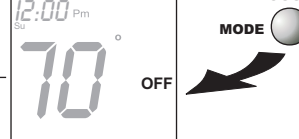

**Note:** If the water temperature is changed during the year, the thermostat will then automatically lock out the incorrect mode. Page 10

## Basic Operation

### Selecting Your Desired Temperature (adjusting the setpoints)

#### AUTO OR PROGRAM MODE

Pressing the UP or DOWN button in Auto or Program mode will adjust **both** the heat and cool set temperatures simultaneously.

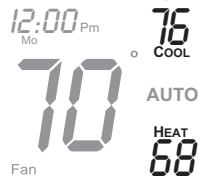

Adjust the desired set temperature with the



buttons.

### Fan Operation

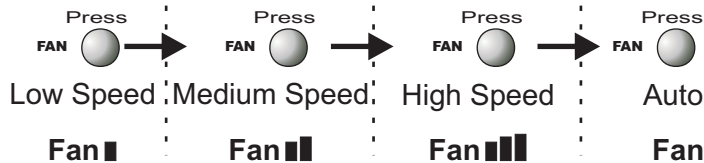
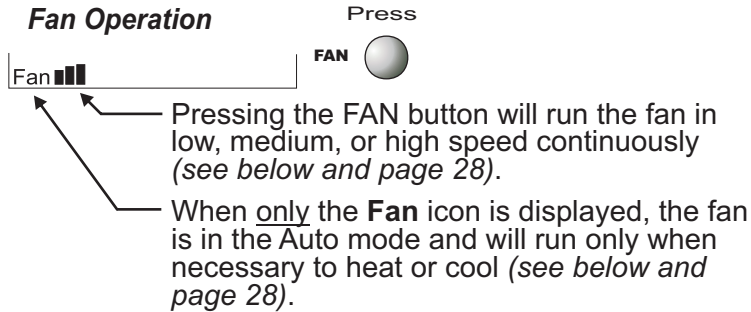

**Note:** If the thermostat is placed in the Off mode, the fan will de-energize (see page 7).

## Basic Operation

### Overriding the Daily Schedule

Pressing and holding the FAN button for 5 seconds may be used to interrupt the normal time schedule programming of the thermostat. The override feature may only be used when the thermostat is running the time schedule, in Program On mode.

**Unoccupied Operation** - During programmed, unoccupied periods pressing and holding the FAN button for 5 seconds will temporarily force the thermostat into Occupied 1 comfort settings for one to six hours (*step #13, page 21*). The Override icon will be illuminated during this time. If you press and hold the FAN button while the thermostat is currently overriding the daily schedule, this will reset the timer, returning the thermostat to the correct time period program for the day.

**Occupied Operation** - Pressing and holding the FAN button for 5 seconds during a programmed Occupied time period will have no effect.

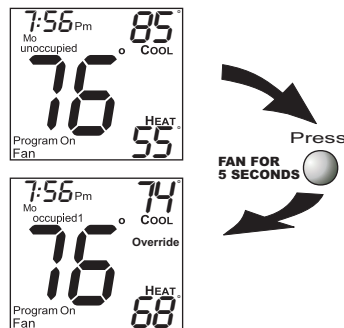

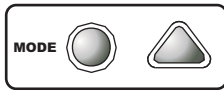

**Programming** Occupied & Unoccupied Periods



**Press the MODE button. While holding MODE, press the UP button for two seconds to enter time period programming.**

 Select the maximum # of occupied periods to be used on any one day. Typically, most installations use only Occupied 1. (1,2 or 3)

 Adjust the cooling setpoint for Occupied 1. (35° - 99° OF )

 Adjust the heating setpoint for Occupied 1. (OF, 35° - 99°)

 Adjust the cooling setpoint for unoccupied periods. (35° - 99° OF )

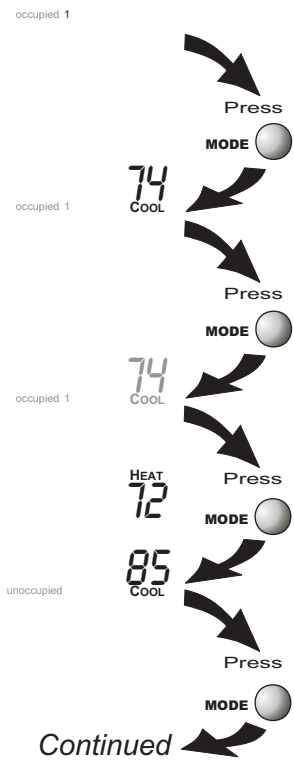

**Programming Occupied & Unoccupied Periods**

 	<p>Adjust the heating set-point for Unoccupied periods. (OF, 35°- 99°)</p>	<p>unoccupied</p> <p>85 COOL</p> <p>HEAT 55</p>	<p>Press MODE</p>
 	<p>Select day of the week for Occupied 1. (Mo - Su)</p>	<p>Mo occupied</p>	<p>Press MODE</p>
 	<p>Adjust the start time for Occupied 1.</p>	<p>7:00 Am Start Mo occupied 1</p>	<p>Press MODE</p>
 	<p>Adjust the stop time for Occupied 1.</p>	<p>6:00 Pm Stop Mo occupied 1</p>	<p>Press MODE</p>
<p>On</p> <p>Off</p>	<p>Select Occupied 1 to run on this day (On), or not to run on this day (Off).</p>	<p>Mo occupied 1</p>	<p>ON</p> <p>Press MODE</p>

## Programming Occupied & Unoccupied Periods

The copy command becomes available after the maximum # of occupied periods are programmed in a day. This example uses 1 as the maximum occupied periods ever programmed in one day.

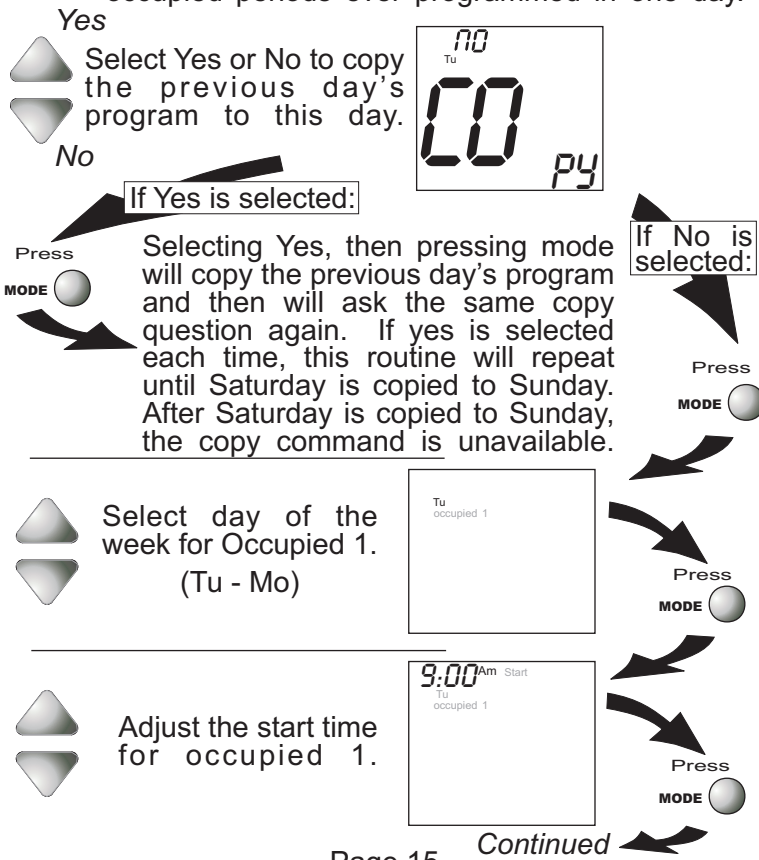

**Programming Occupied & Unoccupied Periods**

 Adjust the stop time for occupied 1.
 5:00Pm Stop  
Tu occupied 1

 Select Occupied 1 to run on this day (On), or not to run this day (Off).
 Tu occupied 1  
ON

 Select Yes or No to copy the previous day's program to this day.
 no  
We  
00  
py

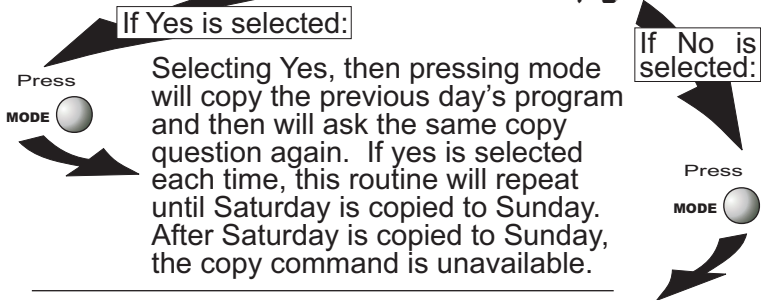

If no is selected, as in previous steps flashing prompts for input will appear for start and stop times for Occupied 1. If more than one occupied period was selected on page 13, then cool/heat setpoints, and start/stop times for additional occupied periods will be prompted.

## Programming Occupied & Unoccupied Periods

### PROGRAMMING NOTES

**\* You will be prompted to enter both heat and cool setpoints even if the thermostat is configured for heat only, or cool only.**

\* If only 1 Occupied period is selected, the Occupied 2 & 3 steps will be skipped. Further, if only 2 occupieds are selected, the Occupied 3 steps will be skipped.

\* Heat & Cool setpoints for Occupied 1 are the same for each day. Heat & Cool setpoints for Occupied 2 & 3 can be adjusted differently for each day, if desired.

\* **If the start time is set for later than the stop time**, the program will run from the start time to midnight and from midnight to the stop time on the same day. *For example: 9:00pm start, 8:00am stop, on MTWTF. This program will run from 12:00am MTWTF to 8:00am MTWTF and again from 9:00pm MTWTF to 12:00pm MTWTF.*

\* The Unoccupied settings take effect at all times when: (1) the program is on **and** (2) the current time is outside a preset occupied period. For this reason start and stop times aren't necessary for unoccupied.

\* If the **same** start and stop times are programmed in for an occupied period, then it will run 24 hours.

\* If one occupied period starts and stops within another occupied period, the lower occupied # has priority. *For example: If Occupied 3 is programmed to be "on" 24 hours, and Occupied 2 is programmed to run that day, then Occupied 2 settings will take over from Occupied 3 between Occupied 2 start and stop times.*

\* When the time period programming for Unoccupied is in the Override mode (see page 12), the Heat & Cool setpoints for Occupied 1 are used.

## Advanced Setup

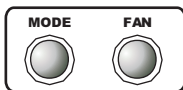

**Press the MODE and FAN buttons at the same time for 10 seconds to enter Advanced Setup screens.**

**NOTE:** Each step # is located at the top right corner of the display for easy reference.

Adjust the time of day. 12:00<sup>Am</sup> Setup 1

*Tip: To change hours quickly, press and hold the FAN button and press the UP or DOWN buttons.*

Select the day of the week. Mo Setup 2

**Display On**

Select Display operation:  
**On** = Full Display  
**Off** = Minimal display

*Display Off See Page 28* d SP Setup 3

**ON**

Continued

## Advanced Setup



Select Display operation:

- 1 = Single Setpoint
- 2 = Dual Setpoint

See Page 32



**Note:** When Single Setpoint is selected, the heating or cooling setpoint will always be displayed. To display the room temperature, press and hold the MODE button for two seconds. The degree icon will blink when the large number is displaying room temperature and will remain solid when displaying the heating or cooling setpoint.

Press  
MODE



Select fan coil system type:

- 2 = 2-pipe fan coil
- 4 = 4-pipe fan coil

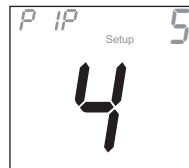

Step #6 only appears if step #5 = 2.

### 2 PIPE SYSTEM OPERATION

- 1= Heat only system
- 2= Cool only system
- 3= Heat/Cool Auto changeover
- 4= Heat/Cool Aux Electric heat, Lockout Electric Heat when Hot Water is available
- 5= Heat/Cool total electric heat, **no** Hot Water, **only** Electric Heat.

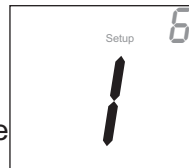



Press  
MODE

Press  
MODE

Continued



**Note: #3 & #4 require accessory changeover sensor** Page 19

## Advanced Setup

 *On*  
 *Off*

Select operation when fan is in the Auto mode:  
**On** = continuous low speed fan  
**Off** = only energize during a heating or cooling cycle.



See Page 28, Note #2



Adjust the deadband for the 1st stage.  
 (1° - 6°)

See Page 25

Step #9 will not appear if step #6 = 1 or 2.

  

Adjust the minimum **difference** between cooling & heating setpoints.  
 (0° - 6°)

 *On*  
 *Off*

Select backlight operation:  
**On** - Light continuously  
**Off** - Light for 8 seconds after a button press

Continued

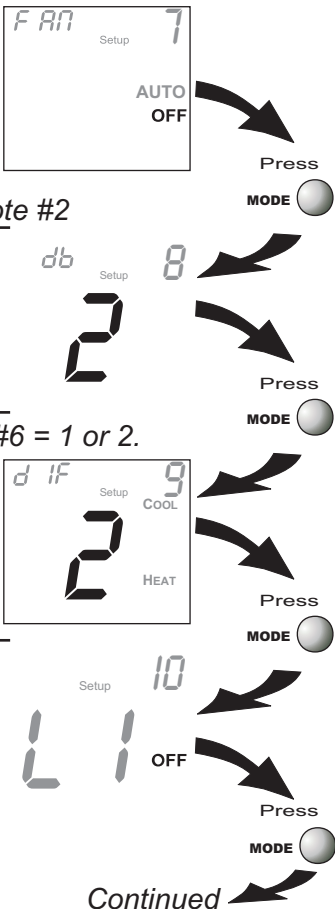

The diagram illustrates the sequence of four advanced setup steps. Each step is shown as a digital display with a 'Setup' label and a value. Step 7 shows 'FAN' and '7'. Step 8 shows 'db' and '2'. Step 9 shows 'dIF' and '2'. Step 10 shows 'LI' and '10'. Arrows indicate the flow from one step to the next, with a 'Press MODE' button icon at the end of each step.

## Advanced Setup

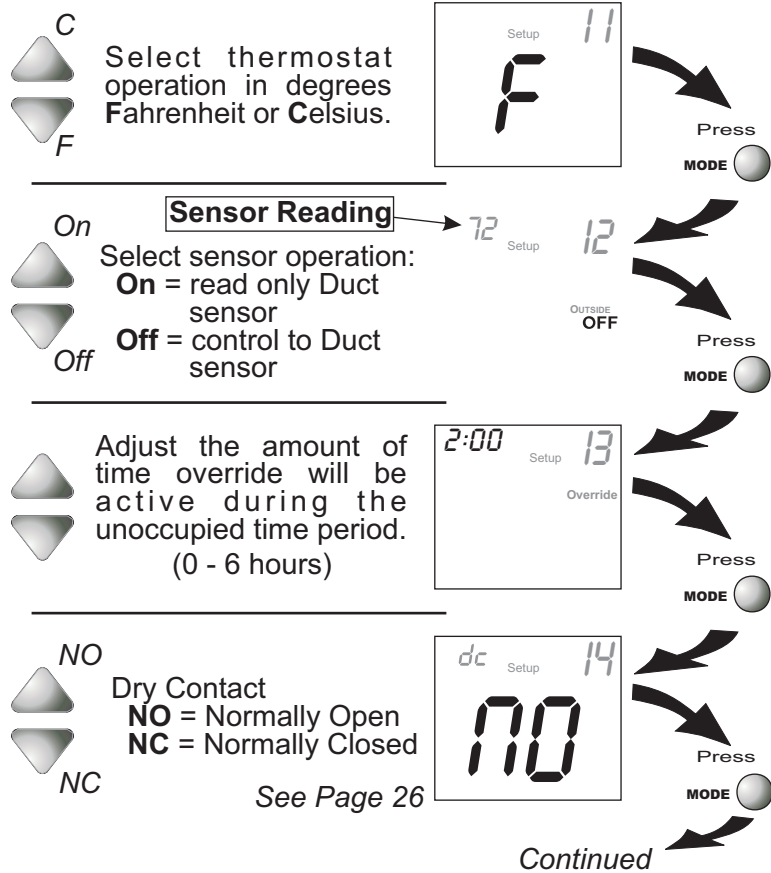

## Advanced Setup

### Occupied



### Unoccupied

Select Dry Contact operation:

**Occupied** = the thermostat will enter the Occupied mode when the Dry Contact is closed.

**Unoccupied** = the thermostat will enter the Unoccupied mode when the Dry Contact is closed.

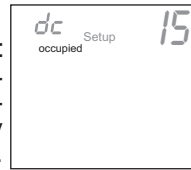

*Step #16 only appears if step #15 = Unoccupied.* Press

### Unoccupied Setpoints



### Off

Select Dry Contact Unoccupied operation:

**Unoccupied** = when the Dry Contact is closed, the thermostat will control to the Unoccupied setpoints.

**Off** = when the Dry Contact is closed, the thermostat will turn off.

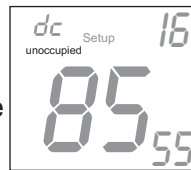

Press



*After programming is complete, press the MODE and FAN buttons at the same time for two seconds to leave the Setup screens. If no buttons are pressed, the display will leave the setup screens after 30 seconds.*

## Advanced Setup

**Advanced Setup Table**

Step #	Description	Range	Factory Default
1	Time of Day	24 hour	12:00 am
2	Day of the Week	Mo - Su	Mo
3	Display Blanking	On / Off	On
4	Single or Dual Setpoint	1 / 2	2
5	2- or 4-Pipe System	2 / 4	4
6	2-Pipe System Operation	1 - 5	1
7	Fan Auto Operation	On / Off	Off
8	Deadband/Temp. Swing 1st Stage	1° - 6°	2°
9	Minimum Heat/Cool Differential	0° - 6°	2°
10	Thermoglow Backlight	On / Off	Off
11	Fahrenheit or Celsius	F / C	F
12	Read Only Duct Sensor?	On / Off	Off
13	Override Timer Length	0 - 6 hours	2 hours
14	Dry Contact Polarity	NO / NC	NO
15	Dry Contact Operation	Occupied / Unoccupied	Occupied
16	Dry Contact Setpoints	Unoccupied / Off	Unoccupied

## About Advanced Features & Operation

- \* CALIBRATION - Under normal circumstances it will not be necessary to adjust the calibration of the temperature sensor. If calibration is required, please contact a trained HVAC technician to correctly perform the following procedure.

1 **MODE** Place the thermostat in the OFF mode.



The display shows the time 12:00 Pm, the day Mo, and the temperature 72°. The mode is set to OFF.

2 **MODE** Press and hold the MODE button. While holding the MODE button, press and hold the DOWN button for 5 seconds. All icons will appear on the display.



The display shows the time 12:00 Am, the day Su, and the temperature 88°. Various icons are visible, including Start Stop, unoccupied 12.3, COOL, Locked, Override, AUTO, OFF, HEAT, and Program On Fan.

3 Press the MODE button once. The thermostat temperature will be displayed and may be calibrated using the UP or DOWN button.

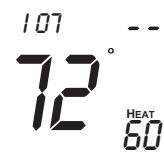

The display shows the time 1:07, the day Mo, and the temperature 72°. The mode is set to HEAT.

4 **MODE** After calibration is complete, press the MODE button **once** to save your changes and return to normal operation.



The display shows the time 12:00 Pm, the day Mo, and the temperature 72°. The mode is set to OFF.

- \* CLOCK BACKUP - In the event of a power loss, the thermostat's internal clock will continue to keep proper time for a minimum of 48 hours without external power or batteries.

## About Advanced Features & Operation

✿ **DEADBAND OPERATION** - Controls one Heat and one Cool stage with a three speed fan (see below).

The **low speed fan** for heat or cool is turned on when: The temperature spread from the setpoint is equal to or greater than: *the setpoint plus the 1st stage deadband (step #8, page 20)*. This 1st stage deadband is adjustable from 1-6 degrees and the default is two degrees.

The **medium speed fan** for heat or cool is turned on when: The temperature spread from the setpoint is equal to or greater than: *the setpoint plus the 1st stage deadband (step #8, page 20), plus the 2nd stage deadband*. This 2nd stage deadband is fixed at one degree and is not adjustable.

The **high speed fan** for heat or cool is turned on when: The temperature spread from the setpoint is equal to or greater than: *the setpoint plus the 1st stage deadband (step #8, page 20), plus the 2nd stage deadband, plus the 3rd stage deadband*. This 3rd stage deadband is fixed at one degree and is not adjustable.

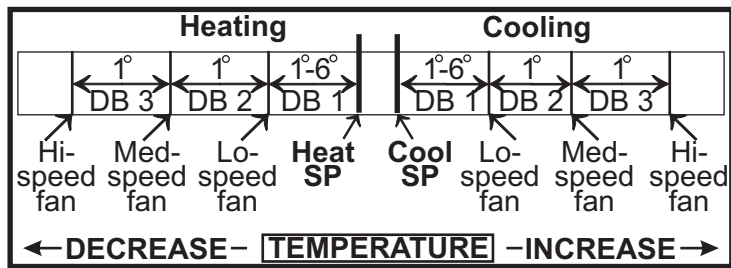

The above figure assumes the minimum on time for the prior stage has been met to allow the next stage to turn on, once the deadbands have been exceeded.

## About Advanced Features & Operation

- ✿ **DRY CONTACT SWITCH** - This feature allows an external device such as a Central Time Clock, Occupancy Sensor, or a Telephone activated device to force one or more thermostats into Occupied 1 or Unoccupied (steps #14 and 15, page 21-22).

When the CK1 and R terminals are shorted together, and the thermostat is programmed for Occupied operation (step #15, page 22) the thermostat will be forced into Occupied 1 setpoints and the Occupied 1 icon will blink.

**Note:** The thermostat must be in Program On mode for this feature to have any effect.

**Important Note:** For control of multiple thermostats by 1 source, refer to the enclosed yellow document P/N 88-175 'Potential Phasing Problems' before installation.

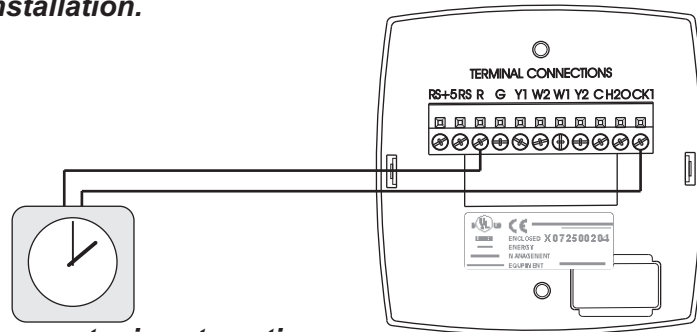

**Connect wires to a time clock or other device to force the thermostat into Occupied 1 or Unoccupied.**

## About Advanced Features & Operation

\* **FACTORY DEFAULTS** - If, for any reason, you desire to return all the stored settings back to the factory default settings, follow the instructions below.

**WARNING: This will reset all Time Period and Advanced Programming to the default settings. Any information entered prior to this reset will be permanently lost.**

1 **MODE** Place the thermostat in the OFF mode. 

2 **MODE** Press and hold the MODE button. While holding the MODE button, press and hold the DOWN button for 5 seconds. All icons will appear on the display. 

3 **FAN** After all of the icons appear, release the MODE and DOWN buttons. Then press and hold the FAN button for 5 seconds. 

4 **MODE** After the letters **Fd** appear on the display (Factory Default), release the FAN button. Press the MODE button **twice** to return to normal operation. 

## About Advanced Features & Operation

- \* FAN OPERATION - Fan operation is available in four different modes:

**Fan:** When only the fan icon is displayed, this indicates that the fan is in the Auto mode, will only energize during a heating or cooling cycle, and will modulate fan speeds based on temperature demand (see page 25).

**Fan■, Fan■■, or Fan■■■:** Pressing the FAN button will cause the low, medium, or high speed fan icon to appear (see page 11), indicating that the fan will run continuously. The fan will de-energize if the thermostat is placed in the Off mode or an unoccupied time period (see page 26).

**Notes:**

1) *If a Duct sensor is connected to this thermostat, then the fan should be programmed for continuous operation (step #7, page 20). This will provide airflow over the Duct sensor and provide more accurate temperature readings.*

2) *If the fan is programmed for continuous operation (step #7, page 20), the low speed fan will run continuously when the fan is in the Auto mode and during occupied time periods, but will de-energize if the thermostat is placed in the Off mode.*

- \* MINIMAL DISPLAY - When the thermostat is programmed for a minimal display (step #3, page 18), only the time of day will appear. When a button is pressed the full, normal display will appear for 10 seconds.

## About Advanced Features & Operation

- \* ENERGY SAVING SMART FAN - This feature automatically de-energizes the fan during an Unoccupied time period, except when necessary to heat or cool (see page 28).

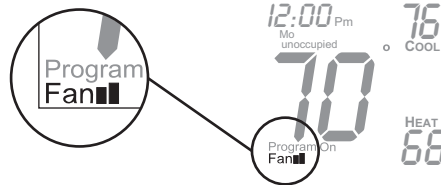

**Note:** The fan will not de-energize during an Unoccupied time period if it has been programmed for continuous operation (step #7, page 20).

- \* HEAT/COOL DIFFERENTIAL - The Heat and Cool setpoints will not be allowed to come any closer to each other than the value set in Advanced Setup step #9, on page 20. This minimum difference is enforced during Auto-changeover and Program On operation.

**Note:** To increase the spread between the heating and cooling setpoints in the Auto-changeover mode press the MODE button until only the heat setpoint is displayed; adjust to the desired setpoint. Press the MODE button until only the cool setpoint is displayed; adjust to the desired setpoint. Press the MODE button again to enter the Auto-changeover mode where both the heat and cool setpoints are displayed.

## About Advanced Features & Operation

- \* **KEYPAD LOCKOUT** - To prevent unauthorized use of the thermostat, the front panel buttons may be disabled. To disable, or 'lock' the keypad, press and hold the MODE button. While holding the MODE button, press the UP and DOWN buttons together. The LOCKED icon will appear on the display, then release the buttons.

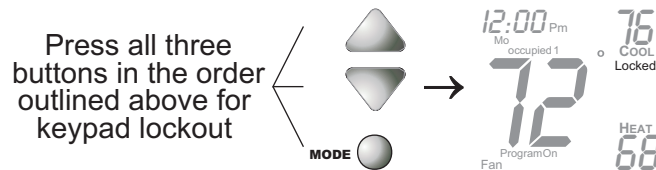

To **unlock** the keypad, press and hold the MODE button. While holding the MODE button, press the UP and DOWN buttons together. The LOCKED icon will disappear from the display, then release the buttons.

- \* **LOCKING COVER**  
w/Tamper Proof Screws  
(G100-71520308 w/ logo  
G100-71520309 w/out logo)

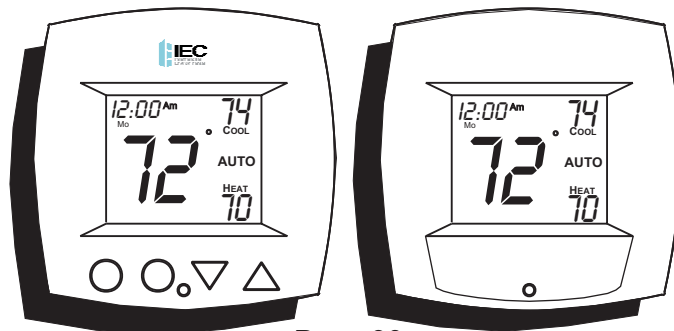

## About Advanced Features & Operation

✿ **OUTSIDE SENSOR** - To view an Outside Sensor (*step #12, page 21*), enter the Advanced Setup by pressing and holding the MODE button. While holding MODE, press the FAN button for 5 seconds to enter Setup screens. Advance to setup step #12 by repeatedly pressing the MODE button. If an optional outside sensor is connected, the outside temperature will appear in the clock display.

✿ **DUCT SENSOR (P/N G100-71520307)** - The thermostat is programmed from the factory to automatically recognize when a Duct Sensor is connected (*step #12, page 21*).

The Duct Sensor measures indoor air temperature and sends this information to the thermostat; it measures temperature with a range of 32° to 99° F.

The Duct Sensor should be connected to the thermostat using solid

conductor CAT 5, CAT 5e, or CAT 6 type network communication cable. This is an unshielded cable with four twisted pairs of 24 gauge solid wire; *DO NOT use stranded cable*. The cable length should not exceed 250 feet. If less than 75 feet of cable is required to connect the thermostat to the Duct Sensor, a three conductor thermostat cable (18-24 gauge) may be used; this cable is NOT suitable for any length greater than 75 feet.

**IMPORTANT:** Do not use shielded wire. Do not run sensor wiring in the same conduit as the 24VAC thermostat wiring. Electrical interference may cause the sensor to give incorrect temperature readings. See the *Duct Sensor instructions* for further details.

Page 31

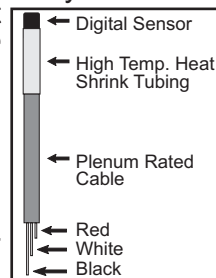

## About Advanced Features & Operation

- \* SINGLE SETPOINT BEHAVIOR - When configured for *Single Setpoint* operation (*step #4, page 19*), the degree icon will blink when the large number is displaying room temperature and will remain solid when displaying the heating or cooling setpoint. In the Auto and Program On modes the deadband is enforced both above and below the setpoint. To avoid short cycling, a deadband of at least two degrees is recommended (*step #8, page 20*). To display the room temperature press and hold the MODE button for two seconds. Release the MODE button to return to the normal display.

## Warranty

### **INTERNATIONAL ENVIRONMENTAL CORPORATION - TERMS AND CONDITIONS**

1. ORDER ACKNOWLEDGEMENTS SHALL ONLY BE BINDING UPON INTERNATIONAL ENVIRONMENTAL CORPORATION (HEREINAFTER REFERRED TO AS IEC) IF GENERATED AND AUTHORIZED BY A REPRESENTATIVE OF IEC AT ITS OFFICE IN OKLAHOMA CITY, OKLAHOMA.
2. IEC DOES NOT BUILD ITEMS TO PLANS AND SPECIFICATIONS. IEC AGREES TO FURNISH ONLY THE ITEMS AS DESCRIBED IN IEC'S ORDER ACKNOWLEDGEMENT UNLESS IEC'S OFFICE IN OKLAHOMA CITY, OKLAHOMA, HAS PREVIOUSLY RECEIVED AND ACCEPTED, IN WRITING, APPROVED SUBMITTALS FROM PURCHASER.
3. PRICES QUOTED ARE FIRM ONLY IF PURCHASER RELEASES THE GOODS COVERED BY THIS ORDER FOR IMMEDIATE PRODUCTION BY IEC WITHIN NINETY (90) DAYS FROM THE DATE OF PURCHASER'S OFFER TO PURCHASE AND FOR SHIPMENT BY IEC WITHIN THE ACKNOWLEDGED SHIPPING DATE WHICH SHALL NOT EXCEED SIX (6) MONTHS FROM THE DATE OF PURCHASER'S OFFER TO PURCHASE. IF PURCHASER DOES NOT MEET THE TERMS AND CONDITIONS OF THIS PARAGRAPH, THE PRICES ARE SUBJECT TO ESCALATION TO THOSE PRICES IN EFFECT AT TIME OF SHIPMENT WITHOUT NOTICE TO PURCHASER.
4. ALL PRICES ARE F.O.B. IEC'S FACTORY WITH FULL FREIGHT ALLOWED UNLESS NOTED OTHERWISE BY IEC. TITLE TO AND RISK OF LOSS TO THE GOODS PASSES TO THE PURCHASER WHEN DELIVERED TO THE CARRIER F.O.B. IEC'S SHIPPING POINT. PURCHASER MUST INSPECT THE GOODS UPON ARRIVAL.
5. IF GOODS ARE RELEASED FOR PRODUCTION BUT IEC IS PREVENTED BY THE PURCHASER FROM SHIPPING UPON COMPLETION OR BY THE ACKNOWLEDGED SHIPPING DATE, WHICHEVER IS LATER, IEC MAY AT ITS OPTION, IN ADDITION TO ALL OTHER REMEDIES, INVOICE THE PURCHASER TO BE PAYABLE WITHIN THIRTY (30) DAYS AND STORE THE GOODS AT PURCHASER'S SOLE EXPENSE.
6. TITLE TO AND RISK OF LOSS TO THE GOODS PASSES TO THE PURCHASER F.O.B. IEC'S SHIPPING POINT.

## Warranty

7. (a.) IEC WARRANTS FOR A PERIOD OF EIGHTEEN (18) MONTHS FROM THE DATE OF SHIPMENT OR TWELVE (12) MONTHS FROM DATE OF START UP (WHICHEVER OCCURS FIRST), THAT THE GOODS SOLD SHALL BE FREE OF DEFECTS IN MATERIAL AND WORKMANSHIP, EXCEPT THAT IEC MAKES NO GUARANTEE AGAINST CORROSION OR ABRASION OF ANY GOODS AND MAKES NO GUARANTEE WHATSOEVER FOR DAMAGES IN ANY WAY RELATING TO MOLD, FUNGUS OR BACTERIA, OR ANY GOODS MANUFACTURED OR SUPPLIED BY OTHERS. IEC MAKES NO OTHER EXPRESS WARRANTY, AND NO AFFIRMATION BY IEC OR ITS REPRESENTATIVES, BY WORD OR ACTION, SHALL CONSTITUTE A WARRANTY.  
(b.) **IEC MAKES NO IMPLIED WARRANTIES OF MERCHANTABILITY OR FITNESS FOR ANY PARTICULAR PURPOSE.**  
(c.) IN THE EVENT OF A BREACH OF THE ABOVE WARRANTY OR NEGLIGENCE ON THE PART OF IEC, IEC SHALL ONLY BE OBLIGATED TO EITHER REPAIR OR REPLACE, AT IEC'S OPTION, THE GOODS, AND THE AFORESAID OBLIGATION OF IEC TO REPAIR OR REPLACE THE GOODS IS THE PURCHASER'S EXCLUSIVE REMEDY. **IEC SHALL NOT, IN ANY MANNER WHATSOEVER, BE LIABLE FOR ANY INCIDENTAL OR CONSEQUENTIAL DAMAGES, LOSS OF PROFITS OR EXPENSES FOR BREACH OF WARRANTY, OR FOR NEGLIGENCE ON THE PART OF IEC.**  
(d.) ALL PARTS SHALL BE RETURNED TO IEC'S FACTORY IN OKLAHOMA CITY, OKLAHOMA, OR OTHER AUTHORIZED SERVICE STATION DESIGNATED BY IEC, FREIGHT PREPAID IF IEC DETERMINES THE PART TO BE DEFECTIVE AND WITHIN IEC'S WARRANTY. IEC SHALL, WHEN SUCH PART HAS BEEN EITHER REPLACED OR REPAIRED, RETURN TO PURCHASER, F.O.B. IEC'S FACTORY IN OKLAHOMA CITY, OK.  
(e.) **THIS WARRANTY SHALL BE VOID FOR ANY GOODS WHICH (1) HAVE BEEN REPAIRED OR ALTERED OUTSIDE IEC'S FACTORY IN ANY MANNER WITHOUT IEC'S WRITTEN AUTHORIZATION; OR (2) HAVE BEEN SUBJECT TO MISUSE, NEGLIGENCE OR ACCIDENTS; OR (3) HAVE BEEN OPERATED IN A MANNER CONTRARY TO IEC'S PRINTED INSTRUCTIONS; OR (4) HAVE NOT BEEN PAID FOR WITHIN PAYMENT TERMS GRANTED BY IEC.**
8. IEC SHALL HAVE NO SYSTEM DESIGN, APPLICATION OR MAINTENANCE RESPONSIBILITY OR RESPONSIBILITY FOR MOLD, FUNGUS OR BACTERIA TO PURCHASER OR ANY OTHER THIRD PARTY.

## Warranty

9. ALL SALES, USE, EXCISE, TRANSPORTATION, PRIVILEGE, OCCUPATIONAL CONSUMPTION, STORAGE, OR OTHER TAXES WHICH MAY BE LEVIED BY ANY TAXING AUTHORITY AS A RESULT OF THIS TRANSACTION SHALL BE PAID BY THE PURCHASER.
10. UNLESS OTHERWISE AGREED TO IN WRITING BY IEC, ANY TECHNICAL DATA, FURNISHED IN CONJUNCTION WITH THIS ORDER AND NOT OBTAINABLE FROM ANOTHER SOURCE SHALL NOT BE DUPLICATED, USED, OR DISCLOSED IN WHOLE OR IN PART FOR ANY PURPOSE OTHER THAN TO EVALUATE THIS ORDER.
11. IEC SHALL HAVE NO LIABILITY OR OTHER OBLIGATION HEREUNDER, IF ITS PERFORMANCE IS DELAYED OR PREVENTED TO ANY EXTENT BY ANY EVENT SUCH AS, BUT NOT LIMITED TO, ANY ACT OF GOD, STRIKE OR WORK STOPPAGE, FIRE, FLOOD, ACCIDENT, ALLOCATION, OR OTHER CONTROLS OF GOVERNMENT AUTHORITIES, SHORTAGE OF TRANSPORTATION, FUEL, MATERIAL AND LABOR, OR ANY OTHER CAUSE BEYOND IEC'S REASONABLE CONTROL. ANY SHIPPING DATE STATED BY IEC IS IEC'S BEST ESTIMATE, BUT IEC MAKES NO GUARANTEE OF SHIPMENT BY ANY SUCH DATE AND SHALL HAVE NO LIABILITY OR OTHER OBLIGATION FOR FAILURE TO SHIP ON SUCH DATE, REGARDLESS OF CAUSE.
12. PAYMENT TERMS ARE NET THIRTY (30) DAYS FROM DATE OF INVOICE ON APPROVED CREDIT. ONE AND ONE-HALF PERCENT (1 1/2%) PER MONTH (18% ANNUAL RATE) MAY BE CHARGED ON PAST DUE ACCOUNTS WHERE PERMITTED BY APPLICABLE LAW. IN THE EVENT ACCOUNT MUST BE PLACED FOR COLLECTION, PURCHASER SHALL BE RESPONSIBLE FOR ALL REASONABLE ATTORNEYS FEES AND COSTS INCURRED BY IEC IN SECURING PAYMENT.
13. PURCHASER SHALL NOT CANCEL THE CONTRACT WITHOUT PRIOR WRITTEN CONSENT OF IEC. IN THE EVENT PURCHASER CANCELS THE CONTRACT WITH THE PRIOR WRITTEN CONSENT OF IEC AFTER THE PURCHASER'S OFFER TO PURCHASE IS RECEIVED AND ACKNOWLEDGED IN WRITING, IEC SHALL BE ENTITLED TO RECEIVE FROM PURCHASER, IEC'S COST PLUS A REASONABLE ALLOWANCE FOR OVERHEAD AND PROFIT.
14. PURCHASER SHALL NOT ASSIGN ANY OF ITS INTEREST RIGHTS UNDER THIS AGREEMENT WITHOUT WRITTEN CONSENT OF IEC.
15. IEC WILL NOT FURNISH LIEN WAIVERS OR RELEASES UNTIL IEC RECEIVES PAYMENT, IN FULL, AT ITS OFFICE IN OKLAHOMA CITY, OKLAHOMA, FROM PURCHASER FOR THE GOODS COVERED BY THIS ORDER. PARTIAL LIEN RELEASES WILL BE PROVIDED IF REQUESTED.

## Warranty

16. ALL ORDERS ARE EXPRESSLY LIMITED AND MADE CONDITIONAL UPON ACCEPTANCE BY PURCHASER OF THE TERMS AND CONDITIONS LISTED ABOVE WITHOUT CHANGE. THERE SHALL BE NO UNDERSTANDINGS, AGREEMENTS, OR OBLIGATIONS (OUTSIDE THESE TERMS AND CONDITIONS) UNLESS SPECIFICALLY SET FORTH IN WRITING, AND ACCEPTED BY SIGNATURE OF AN AUTHORIZED REPRESENTATIVE OF IEC IN OKLAHOMA CITY, OKLAHOMA.

1100-90006968

P/N 88-569  
Rev. 2